



BANSHEE TUBE CLEANING NOZZLES USER MANUAL

**INCLUDES" 40K MODEL*

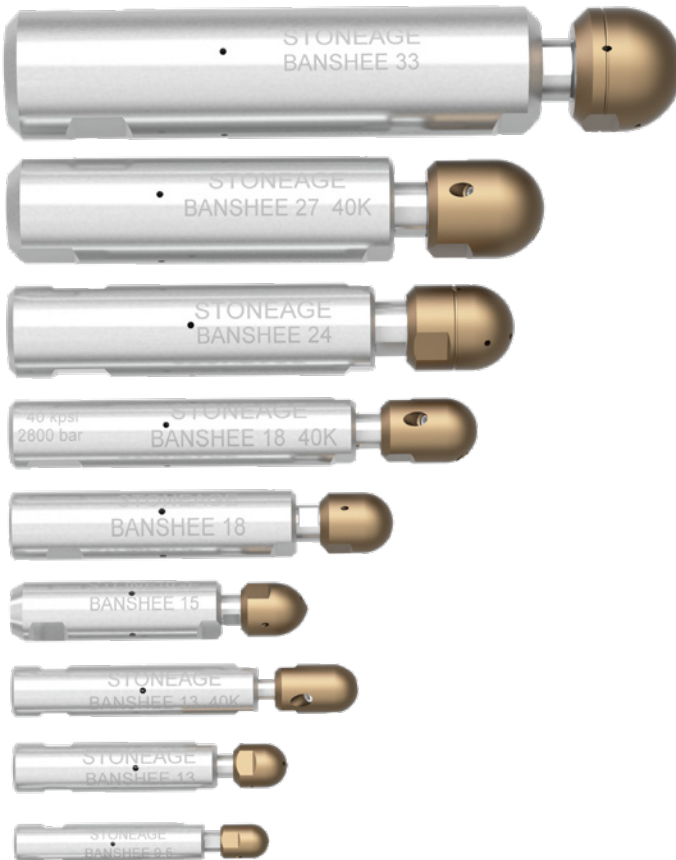

TABLE OF CONTENTS

MANUFACTURER'S INFORMATION	3
SPECIFICATIONS FOR ALL MODELS	3
KEY FEATURES FOR ALL MODELS	3
WARNING AND SAFETY INSTRUCTIONS	4
22K PSI (1500 BAR) BANSHEE	5
HEAD CONFIGURATIONS AND INLET CONNECTIONS	5
OPERATION	6
TROUBLESHOOTING	6
TYPES OF APPLICATIONS	7
MAINTENANCE AND PARTS	8
40K PSI (2800 BAR) BANSHEE	10
HEAD CONFIGURATIONS AND INLET CONNECTIONS	10
OPERATION	11
TROUBLESHOOTING	11
MAINTENANCE AND PARTS	12
22K PSI (1500 BAR) TOOL NUMBERS	13
40K PSI (2800 BAR) TOOL NUMBERS	15
TERMS AND CONDITIONS AND WARRANTY	16

This manual must be used in accordance with all applicable national laws. The manual shall be regarded as a part of the machine and shall be kept for reference until the final dismantling of the machine, as defined by applicable national law(s).

Updated manuals can be downloaded at:
<https://www.stoneagetools.com/manuals>

StoneAge Inc.
466 S. Skylane Drive
Durango, CO 81303, USA
Phone: 970-259-2869
Toll Free: 866-795-1586
www.stoneagetools.com

StoneAge Europe
Unit 3 Crucible Business Park
Woodbury Lane, Norton, Worcester,
Worcestershire, WR5 2DQ
United Kingdom
Phone: +44 (0) 1684 892065

Banshee Model Specifications

Model	Tube ID Range		*Pressure Range		Flow Range		Cv	Tool Diameter		Tool Length		Max Water Temp	
	in.	mm	Kpsi	bar	gpm	lpm		in.	mm	in.	mm	°F	°C
BN9.5	.47-.63	12-16	8-22	550-1500	5-6	19-23	.20	.37	9.5	2.6	65	250	120
BN13	.6-1.0	15-25	8-22	550-1500	7-9	26-34	.27	.5	13	2.9	74	250	120
40k BN13	.6-1.0	15-25	20-40	1400-2800	4.5-6	17-23	.20	.5	13	3.5	89	250	120
BN15	.75-1.2	19-30	8-22	550-1500	8-10	30-38	.35	.6	15	3.0	76	250	120
BN18	.87-1.3	22-33	8-22	550-1500	8-14	30-53	.66	.69	18	3.8	97	250	120
40k BN18	.87-1.3	22-33	20-40	1400-2800	5-8.5	19-32	.25	.69	18	4.7	120	250	120
BN24	1.1-2.0	28-51	8-22	550-1500	11-24	28-51	.90	.93	24	5.1	130	250	120
40k BN27	1.25-2.0	32-51	20-40	1400-2800	5-8.5	19-32	.30	1.06	27	5.5	140	250	120
BN33	1.5-2.4	38-60	8-22	550-1500	11-48	42-182	2.3	1.3	33	6.9	180	250	120

* The Maximum working pressure for different Banshee swivels is dependent on the inlet connection. See the "Banshee Head Configurations" pages for lists of the various Inlet connections

DESCRIPTION OF EQUIPMENT AND INTENDED USE

Banshee tube cleaning nozzles use high pressure water as a liquid bearing, thereby eliminating ball bearings, seals or lubricant used in conventional rotary tools. Each tool is easily configured to suit any application by choosing from a variety of replaceable heads and inlet options.

APPLICATIONS:

- Unplugging, cleaning, and polishing tubes, such as those found in heat exchangers and industrial tube bundles
- Effectively removes thin, hard scale, carbons, coke, and polymers
- Ideal for manual and powered lancing operations

KEY FEATURES:

- Patented liquid bearing design means no bearings, seals or lubricants to replace
- Stainless steel construction for extreme durability and longevity
- Multiple inlet options and replaceable heads make configurations easy

WARNING AND SAFETY INSTRUCTIONS

▲WARNING

Operations with this equipment can be potentially hazardous. Caution must be exercised prior to and during machine and water jet tool use. Please read and follow all of these instructions, in addition to the guidelines in the WJTA Recommended Practices handbook, available online at www.wjta.org. Deviating from safety instructions and recommended practices can lead to severe injury and/or death.

- Do not exceed the maximum operating pressure specified for any component in a system. The immediate work area must be marked off to keep out untrained persons.
- The *Dump Valve* is the most important safety device. Each operator must have and be able to use their own Dump Valves to shut down the water pressure immediately if necessary.
- Inspect the equipment and nozzle for visible signs of deterioration, damage, and improper assembly. Do not operate until repaired. Make sure all threaded connections are tight and free of leaks.
- All operators and persons in close proximity must wear personal protective equipment, including approved protection for body, hands, feet, face, ears, eyes, and air passages. Please refer to the WJTA Recommended Practices, Section 6.
- Water pressure greater than 20,000 psi (1379 bar) can reach 200°F (93°C) and can scald or burn the operator. Always use face shields, water jet resistant armor, and gloves to protect the operator from being burned or cut.
- Inspect the high pressure hose for damage. Use ONLY hoses or flex lances intended for waterblast applications and rated for the maximum operating pressure on the job. The high pressure hose crimp/end fitting should be equal to or less than the diameter of the BANSHEE tool. The high pressure hose should be as large as possible to minimize pressure loss through the hose. There is increased risk of hydrauliccking when cleaning plugged tubes, when using larger ends.
- A *Stinger* is a rigid piece of pipe or tubing used between the end of the hose and the BANSHEE tool. It is usually 2 feet but can vary in length and is primarily a safety device for hand lancing. DO NOT use the stinger as a pry bar or to bang on a deposit. The stinger and/or BANSHEE may break or stop rotating while being forced against a blockage. The coupling connecting the hose to the stinger should be of the *Slimline* type and no larger in diameter than the BANSHEE tool body. Material could catch on a coupling that is greater in diameter and cause hydrauliccking to occur.

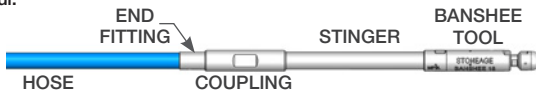

- An *Anti-Withdrawal Device* must be used when flex lancing. These devices provide a mechanical stop to prevent the waterjet tool from exiting the tube and injuring the operator during the cleaning operation. StoneAge automated, hands-free, equipment is designed to protect the operator and provide backout prevention. If StoneAge automated equipment is not being used with the flex lances then one of two StoneAge backout prevention options should be used.

The **VE-400 Safety Stop** is designed to protect the operator from a flex-lance exiting the tube sheet during cleaning operations.

The **ProTex BPT-100** vertical splash guard is lightweight and durable to keep operators safe from the potential hazards of flex-lancing.

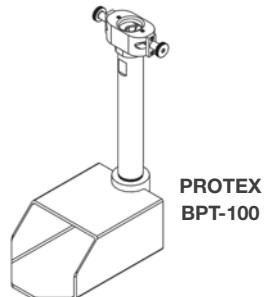
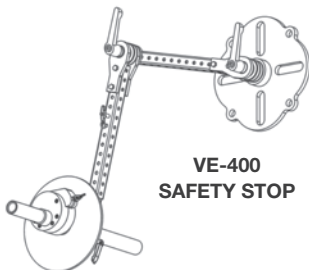

22K PSI (1500 BAR) BANSHEE HEAD CONFIGURATIONS

The BANSHEE tool diameter and inlet nut connection determine the operating pressure and part number. BANSHEE tools can be used at operating pressures ranging from 1000psi (69 Bar) to 22,000psi (1500 Bar). The pull of the three standard heads ranges from 3 to 5 pounds and is capable of a range of pressures and flows.

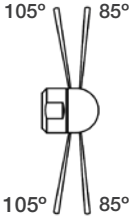

POLISHER 042
4 Ports: 2 @ 85°, 2 @ 105°

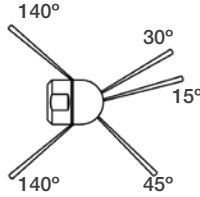

UNPLUGGER 043
5 Ports: 1 @ 15°, 1 @ 30°
1 @ 45°, 2 @ 145°

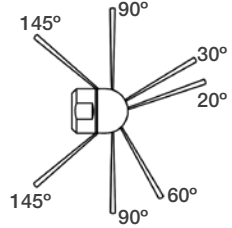

UNIVERSAL 044
7 Ports: 1 @ 20°, 1 @ 30°
1 @ 60°, 2 @ 90°, 2 @ 145°

*BSPP=British Standard Pipe LH= Left Hand RH=Right Hand
MP=Medium Pressure NPT=National Pipe Thread

Table 1 - Tool Specifications

Part Number	*Inlet Connection	Max Pressure
BN9.5-P1	1/16 NPT	15kpsi / 1035 bar
BN9.5-M7	M7-1.0	22kpsi / 1500 bar
BN9.5-MP4L	1/4-28 LH	22kpsi / 1500 bar
BN9.5-MP4R	1/4-28 RH	22kpsi / 1500 bar
BN9.5-S5M	5/16-24 RH	22kpsi / 1500 bar
BN13-P2	1/8 NPT	15kpsi / 1035 bar
BN13-BSPP2	1/8 BSPP	18kpsi / 1250 bar
BN13-MP4L	1/4-28 LH	22kpsi / 1500 bar
BN13-MP4R	1/4-28 RH	22kpsi / 1500 bar
BN13-MP6L	3/8-24 LH	22kpsi / 1500 bar
BN13-MP6R	3/8-24 RH	22kpsi / 1500 bar
BN15-P2	1/8 NPT	15kpsi / 1035 bar
BN15-BSPP2	1/8 BSPP	18kpsi / 1250 bar
BN15-MP6L	3/8-24 LH	22kpsi / 1500 bar
BN15-MP6R	3/8-24 RH	22kpsi / 1500 bar
BN18-P4	1/4 NPT	15kpsi / 1035 bar
BN18-BSPP4	1/4 BSPP	20kpsi / 1400 bar
BN18-MP9L	9/16-18 LH	22kpsi / 1500 bar
BN18-MP9R	9/16-18 RH	22kpsi / 1500 bar
BN24-P6	3/8 NPT	15kpsi / 1035 bar
BN24-BSPP6	3/8 BSPP	22kpsi / 1500 bar
BN24-MP9L	9/16-18 LH	22kpsi / 1500 bar
BN24-MP9R	9/16-18 RH	22kpsi / 1500 bar
BN33-P8	1/2 NPT	15kpsi / 1035 bar
BN33-BSPP8	1/2 BSPP	22kpsi / 1500 bar
BN33-MP9	9/16 MP	22kpsi / 1500 bar

Table 2 - Head Options

Part Number	Pressure Range	Flow
BN9.5-A	10,000 -15,000 psi	5-6 gpm
-B	15,000 -22,000 psi	5-6 gpm
BN13-A	8,000 -15,000 psi	7-10 gpm
-C	12,000 -22,000 psi	7-10 gpm
BN15-A	8,000 -15,000 psi	7-10 gpm
-C	12,000 -22,000 psi	7-10 gpm
BN18-A	8,000 -15,000 psi	11-14 gpm
-B	8,000 -15,000 psi	8-10 gpm
-C	12,000 -22,000 psi	11-14 gpm
-D	12,000 -22,000 psi	8-10 gpm
BN24-A	8,000 -15,000 psi	19-24 gpm
-B	8,000 -15,000 psi	14-18 gpm
-C	8,000 -15,000 psi	11-13 gpm
-D	12,000 -22,000 psi	17-20 gpm
-E	12,000 -22,000 psi	14-16 gpm
-F	12,000 -22,000 psi	11-13 gpm
BN33-A	8,000 -15,000 psi	39-48 gpm
-B	8,000 -15,000 psi	32-38 gpm
-C	8,000 -15,000 psi	25-31 gpm
-D	8,000 -15,000 psi	19-24 gpm
-E	8,000 -15,000 psi	14-18 gpm
-F	12,000 -22,000 psi	21-25 gpm
-G	12,000 -22,000 psi	17-20 gpm
-H	12,000 -22,000 psi	14-16 gpm
-I	12,000 -22,000 psi	11-13 gpm

22K PSI (1500 BAR) BANSHEE OPERATION

⚠ WARNING

Operators **MUST** adhere to the “Warning and Safety Instructions” section in this manual.

OPERATION STEPS:

1. Flush out the entire system before installing the BANSHEE tool on the end of the hose or stinger. A clean water supply is needed for reliable operation and should contain no larger than 25 micron particulates.
2. Once the system is flushed, attach the BANSHEE tool and place it in an open tube while the operating pressure is being set.
3. When the tool is at operating pressure, the water exiting the tool through the leak paths/weep holes will keep external debris from entering the tool.
4. If the tool is not under pressure it should not be left inside a plugged tube. Doing so could allow debris to enter and prevent rotation or cause damage to the tool.
5. If the tool does not rotate when the dump valve is closed, the operator should try closing the dump valve slowly a few times to build up pressure until normal operation is achieved. This will also flush debris from the tool.
6. The BANSHEE drilled nozzle head will last between 20 and 60 hours. Worn jets decrease the cutting rate. The tool may begin to hydraulick when cleaning plugged tubes. This occurs when the jets are not effectively cutting the material into smaller pieces.
7. When using BANSHEE tools in plugged tubes, do not jam the head into the deposit because this will stop the rotation of the tool and impede the cutting ability. When the tool contacts the deposit, allow it to cut away the material and advance at its own pace. If it stops advancing, pull back slightly on the hose to move the head away from the deposit. This action also allows the jets to cut the deposit at different angles. The hose should be gradually fed into and out of the tube, allowing time for the jets to do their work. Repeat this process until the tube is unplugged.
8. When polishing tubes with scale, the tool has been observed passing through a 50 foot long scaled tube in 10 seconds. While this is sufficient when cleaning easy-to-remove deposits, we recommend feeding the tool through the tube at a slower rate. This will ensure adequate cleaning. Unless the deposit is very easy to remove, this will not completely remove the scale.

NOTICE

Corrosion pitting is one of the most common failures of BANSHEE tools. Pitting can cause premature tool failure due to cracking. StoneAge recommends the following to help extend the life of the BANSHEE tools.

After use, blow out excess water and debris.

Flush the tool with WD-40®

Store tool in WD-40®

22K PSI (1500 BAR) BANSHEE TROUBLESHOOTING

TOOL WILL NOT ROTATE:

- All BANSHEE tools have a tapered shaft that fits into a tapered body. These surfaces do not touch during operation. Do not pull out on the head/shaft in order to rotate the tool, it will lock up. If this happens, tap the head/shaft on a surface to knock it free.
- Operators should be cautioned not to pry sideways on the tool. This may break the shaft just behind the head, particularly if a rigid stinger is being used in the inlet.
- Check the nozzle orifices in the head for plugging; if one becomes plugged the swivel will likely not rotate. If this does not solve the problem, the swivel should be disassembled and inspected.
- There are four small holes exiting the tapered portion of the shaft; these should be checked for debris and cleaned out. Blow out the body and wipe off the shaft to remove any debris.

WD-40® is a registered trademark of the WD-40 Corporation.

DIFFERENT TYPES OF BANSHEE APPLICATIONS

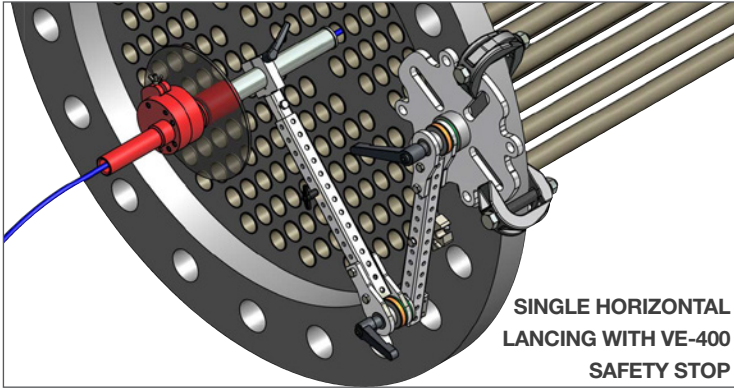

**SINGLE VERTICAL LANCING
WITH PROTEX BPT-100**



**DUAL OR TRIPLE
HORIZONTAL LANCING WITH
HANDS-FREE AUTOBOX® TRACTOR**

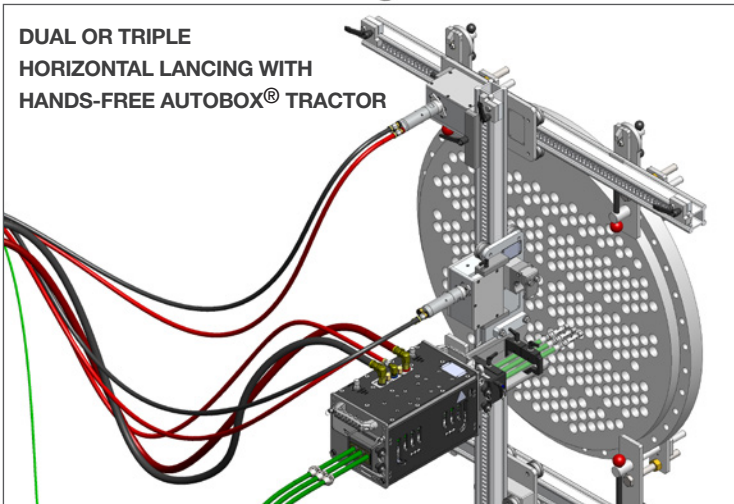

NOTICE

DO NOT USE A PIPE WRENCH OR PLIERS WITH TEETH

This can crush and crack the hardened steel body, leading to tool breakage during operation.

The nozzle heads are wear items that will need to be replaced after 20 to 60 hours, depending on water filtration and operating pressure. All BANSHEE tools require the use of a correctly sized open-end wrench to fit the flats provided on the inlet nut when attaching the tool to the lance. The wrench flats should always be used when maintaining these tools. TABLE 3 details the wrench size required for each part of the tools and the available kits that contain the wrenches for each tool model.

Table 3 - Recommended Torque Ranges and Required Wrench Sizes

StoneAge Tool Kit Number	Part	Wrench Size (in)	Recommended Torque Ranges (with anti-seize)					
			IN-LBS		FT-LBS		N-m	
BN9.5 612	Shaft	3/16	36	40	3	3.3	4.1	4.5
	Head	5/16						
	Body	11/32	194	216	16	18	22	24.4
	Nut	5/16						
BN13 612	Shaft	13/64	63	70	5	5.8	7.1	7.9
	Head	3/8						
	Body	7/16	270	300	23	25	30.5	33.9
	Nut	7/16						
BN15 612	Shaft	1/4	108	120	9	10	12.2	13.6
	Head	1/2						
	Body	1/2	315	350	26	29	35.6	39.5
	Nut	1/2						
BN18 612	Shaft	5/16	180	200	15	16.7	20.3	22.6
	Head	9/16						
	Body	9/16	540	600	45	50	61	67.8
	Nut	5/8						
BN24 612	Shaft	1/2	432	480	36	40	48.8	54.2
	Head	13/16						
	Body	13/16	756	840	63	70	85.4	94.9
	Nut	13/16						
BN33 612	Shaft	9/16	486	540	41	45	54.9	61
	Head	1-1/8						
	Body	1-1/8	1080	1200	90	100	122	135.6
	Nut	1-1/8						

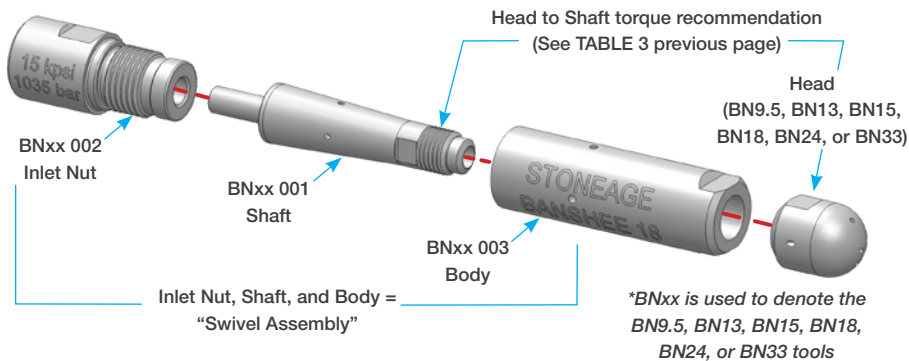

DISASSEMBLY STEPS:

1. Layout the appropriate size open end wrenches for the tool intended for maintenance. See Table 3 on the previous page for list of wrench sizes.
2. Locate the flats on the Head and tighten them in a vice, so that the nut end of the tool is facing up.
3. Slide a wrench onto the flats of the Shaft and loosen the Swivel Assembly from the head.
4. Remove the BANSHEE from the vice and unscrew the Head from the Swivel Assembly.
5. Place an adjustable 1-1/8" wrench in the vice, so the flat side of the claw is parallel to the floor.
6. Slide the Inlet Nut flats into the open end wrench. Using a second open end wrench on the Body flats, loosen the Body from the Inlet Nut and unscrew.
7. The Shaft should just drop out of the Body and the Disassembly is complete.

CLEAN:

1. Use a pin gauge or needle to make sure all orifices in all four parts are free of debris. The holes in the Shaft are critical for proper rotation.
2. After cleaning each part, blow out excess water.

INSPECT:

1. Heads are designed for 20-60 hours of wear dependent upon water quality and operating pressure. Worn head will decrease the cutting rates and overall productivity. Inspect the head for dents, pock marks, and jets. When in doubt replace the Head.
2. Inspect the Shaft for cracking, pitting, or uneven wear.

ASSEMBLY STEPS:

1. Position the stem of the Shaft into the Inlet Nut.
2. Slide the Body over the Shaft and screw onto the Inlet Nut.
3. Place an adjustable 1-1/8" wrench in the vice, so the flat side of the claw is parallel to the floor. Slide the Inlet Nut flats into the open end wrench. Using a second open end wrench on the Body flats, tighten the Body to the Inlet Nut.
4. Screw the Head onto the Shaft. Locate the flats on the Head and tighten them in a vice, so that the nut end of the tool is facing up.
5. Slide a wrench onto the flats of the Shaft and tighten the Swivel Assembly to the head.

NOTICE

Corrosion pitting is one of the most common failures of BANSHEE tools. Pitting can cause premature tool failure due to cracking. StoneAge recommends the following to help extend the life of the BANSHEE tools.

*After use, blow out excess water and debris.
Flush the tool with WD-40®
Store tool in WD-40®*

40K PSI (2800 BAR) BANSHEE

The 40k psi (2800 bar) BANSHEES are self-rotating swivels designed for tube cleaning. The diameter of the tool and inlet nut connection determine the model and part number. The tool can be used at operating pressures from 25,000 psi to 40,000 psi, depending on the inlet connection and head jetting. Unlike the lower pressure Banshees, the 40k psi (2800 bar) BANSHEE heads come with threaded replaceable sapphire nozzle inserts

NOZZLE HEADS:

Two standard head designs are available and both are capable of a range of pressure and flows. The nozzles in all heads are all OS2 Sapphire nozzles. Different orifice sizes in the nozzles accommodate different pressure and flow combinations. Refer to TABLE 7 for Head Jetting and Flow specifications. The pull of the standard heads ranges from 3.5 to 4 pounds.

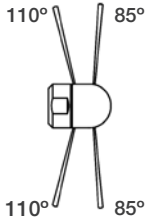

POLISHER 442
4 Ports: 2 @ 85°, 2 @ 110°

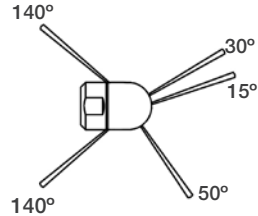

UNPLUGGER 443
5 Ports: 1 @ 15°, 1 @ 30°
1 @ 50°, 2 @ 140°

Table 6 - Tool Specifications

Part Number	*Inlet Connection	Max Pressure
BN13-H4L	14-28 LH	40kpsi / 2800 bar
BN13-H6L	3/8-24 LH	40kpsi / 2800 bar
BN18-H6L	3/8-24 LH	40kpsi / 2800 bar
BN18-H9L	9/16-18 LH	40kpsi / 2800 bar
BN18-H9R	9/16-18 RH	40kpsi / 2800 bar
BN18-HM14L	M14 x 1.5 LH	40kpsi / 2800 bar
BN27-H9L	9/16-18 LH	40kpsi / 2800 bar
BN27-HM14L	M14 x 1.5 LH	40kpsi / 2800 bar

*BSPP=British Standard Pipe LH= Left Hand RH=Right Hand
MP=Medium Pressure NPT=National Pipe Thread

Table 7 - Head Options

Part Number	OS2-0XX Front Jet Size	OS2-0XX Back Jet Size	Flow
BN13 442-C	2 x .014	2 x .015	5.5-6 gpm
-D	2 x .010	2 x .014	4.5-5 gpm
BN13 443-C	3 x .010	2 x .016	5.5-6 gpm
-D	3 x .009	2 x .015	4.5-5 gpm
BN18 442-A	2 x .020	2 x .017	8-8.5 gpm
-B	2 x .018	2 x .017	7-7.5 gpm
-C	2 x .015	2 x .015	6-6.5 gpm
-D	2 x .010	2 x .014	5-5.5 gpm
BN18 443-A	3 x .014	2 x .020	8-8.5 gpm
-B	3 x .013	2 x .019	7-7.5 gpm
-C	3 x .011	2 x .016	6-6.5 gpm
-D	3 x .009	2 x .014	5-5.5 gpm
BN27 442-A	2 x .018	2 x .018	8-8.5 gpm
-B	2 x .015	2 x .016	7-7.5 gpm
-C	2 x .011	2 x .015	6-6.5 gpm
-D	2 x .009	2 x .013	5-5.5 gpm
BN27 443-A	3 x .013	2 x .019	8-8.5 gpm
-B	3 x .011	2 x .017	7-7.5 gpm
-C	3 x .009	2 x .014	6-6.5 gpm
-D	3 x .006	2 x .013	5-5.5 gpm

▲ WARNING

Operators **MUST** adhere to the “Warning and Safety Instructions” section in this manual.

OPERATION STEPS:

1. Flush out the entire system before installing the BANSHEE tool on the end of the hose or stinger. A clean water supply is needed for reliable operation and should contain no larger than 25 micron particulates.
2. Once the system is flushed, attach the BANSHEE tool and place it in an open tube while the operating pressure is being set.
3. When the tool is at operating pressure, the water exiting the tool through the leak paths/weep holes will keep external debris from entering the tool.
4. If the tool is not under pressure it should not be left inside a plugged tube. Doing so could allow debris to enter and prevent rotation or cause damage to the tool.
5. If the tool does not rotate when the dump valve is closed, the operator should try closing the dump valve slowly a few times to build up pressure until normal operation is achieved. This will also flush debris from the tool.
6. Sapphire nozzles can last several hundred hours with proper care. Worn jets decrease the cutting rate. The tool may begin to hydraulick when cleaning plugged tubes. This occurs when the jets are not effectively cutting the material into smaller pieces.
7. When using BANSHEE tools in plugged tubes, do not jam the head into the deposit because this will stop the rotation of the tool and impede the cutting ability. When the tool contacts the deposit, allow it to cut away the material and advance at its own pace. If it stops advancing, pull back slightly on the hose to move the head away from the deposit. This action also allows the jets to cut the deposit at different angles. The hose should be gradually fed into and out of the tube, allowing time for the jets to do their work. Repeat this process until the tube is unplugged.
8. When polishing tubes with scale, the tool has been observed passing through a 50 foot long scaled tube in 10 seconds. While this is sufficient when cleaning easy-to-remove deposits, we recommend feeding the tool through the tube at a slower rate. This will ensure adequate cleaning. Unless the deposit is very easy to remove, this will not completely remove the scale.

NOTICE

Corrosion pitting is one of the most common failures of BANSHEE tools. Pitting can cause premature tool failure due to cracking. StoneAge recommends the following to help extend the life of the BANSHEE tools.

After use, blow out excess water and debris.

Flush the tool with WD-40®

Store tool in WD-40®

40K PSI (2800 BAR) BANSHEE TROUBLESHOOTING

TOOL WILL NOT ROTATE:

- All BANSHEE tools have a tapered shaft that fits into a tapered body. These surfaces do not touch during operation. Do not pull out on the head/shaft in order to rotate the tool, it will lock up. If this happens, tap the head/shaft on a surface to knock it free.
- Operators should be cautioned not to pry sideways on the tool. This may break the shaft just behind the head, particularly if a rigid stinger is being used in the inlet.
- Check the nozzle orifices in the head for plugging; if one becomes plugged the swivel will likely not rotate. If this does not solve the problem, the swivel should be disassembled and inspected.
- There are two small holes exiting the tapered portion of the shaft; these should be checked for debris and cleaned out. Blow out the body and wipe off the shaft to remove any debris.

OS2 SAPPHIRE NOZZLES:

The life of the sapphire nozzle inserts depends on water filtration. If any particle hits the sapphire, it will be instantly ruined. With clean water and proper care, they can last for several hundred hours. 40K BANSHEE wrench kits also include a 1/16" allen and LOCTITE® 680 for replacing the nozzles.

REPLACING SAPPHIRE NOZZLES:

1. To remove worn nozzle inserts, heat the head with a propane torch for a minute or just enough to break down the thread-locker.
2. All nozzle inserts can be installed using the 1/16" allen wrench and a drop of the LOCTITE® 680 provided in the wrench kits.

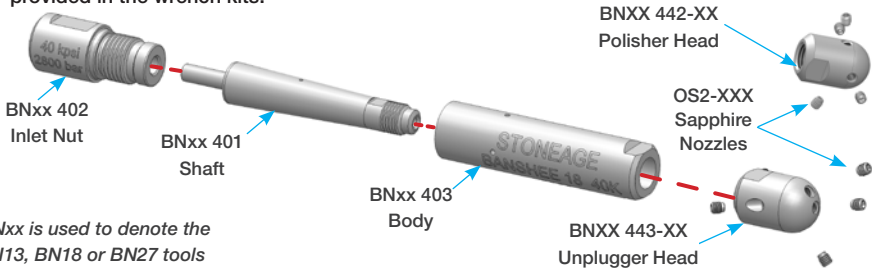

*BNxx is used to denote the BN13, BN18 or BN27 tools

NOTICE

DO NOT USE A PIPE WRENCH OR PLIERS WITH TEETH

This can crush and crack the hardened steel body, leading to tool breakage during operation.

*StoneAge does NOT recommend replacing 40k BANSHEE (with the exception of OS2 nozzles) due to tight tolerances and unknown or uncontrolled condition and fit of the original parts.





All BANSHEE tools require the use of a correctly sized open-end wrench to fit the flats provided on the inlet nut when attaching the tool to the lance. The wrench flats should always be used when maintaining these tools. TABLE 8 details the wrench size required for each part of the tools and the available kits that contain the wrenches, one 1/6" allen hex key, and LOCTITE® 680 for each tool model.

Table 8 - Recommended Torque Ranges and Required Wrench Sizes



StoneAge Tool Kit Number	Part	Wrench Size (in)	Recommended Torque Ranges (with anti-seize)					
			IN-LBS		FT-LBS		N-m	
BN13 612-H	Shaft	3/16	63	70	5	5.8	7.1	7.9
	Head	5/16						
	Body	11/32	270	300	23	25	30.5	33.9
	Nut	5/16						
BN18 612-H6L	Shaft	13/64	180	200	15	16.7	20.3	22.6
	Head	3/8						
	Body	7/16	540	600	45	50	61	67.8
	Nut	7/16						
BN27 612-H9L	Shaft	1/2	432	480	36	40	48.8	54.2
	Head	7/8						
	Body	15/16	918	1020	77	85	103.7	115.2
	Nut	15/16						

LOCTITE® is a registered trademark of the Henkel Corporation.



22K (1500 BAR) TOOL NUMBERS

PRESSURE		PART NUMBER	STYLE	FLOW RANGE		
Kpsi	bar			gpm	lpm	
BN9.5 HEAD SELECTION						
10-15	700-1000	BN9.5 042-A	Polisher	4.5-5.5	17-21	
		BN9.5 043-A	Unplugger	5-6	19-23	
15-22	1000-1500	BN9.5 042-B	Polisher	5-6	19-23	
		BN9.5 043-B	Unplugger	5.5-6.5	21-25	
		BN9.5 044-1	Universal	7.0-8.0	27-30	
BN13 HEAD SELECTION						
10-15	700-1000	BN13 042-A	Polisher	7-9	27-34	
		BN13 043-A	Unplugger	7-9	27-34	
		BN13 044-A	Universal	8-10	30-38	
15-22	1000-1500	BN13 042-C	Polisher	7-9	27-34	
		BN13 043-C	Unplugger	7-9	27-34	
		BN13 044-C	Universal	8-10	30-38	
BN15 HEAD SELECTION						
10-15	700-1000	BN15 042-A	Polisher	7-9	27-34	
		BN15 043-A	Unplugger	7-9	27-34	
		BN15 044-A	Universal	8-10	30-38	
15-22	1000-1500	BN15 042-C	Polisher	7-9	27-34	
		BN15 043-C	Unplugger	7-9	27-34	
		BN15 044-C	Universal	8-10	30-38	
BN18 HEAD SELECTION						
10-15	700-1000	BN18 042-A	Polisher	11-14	42-53	
		BN18 042-B	Polisher	8-10	30-38	
		BN18 043-A	Unplugger	11-14	42-53	
		BN18 043-B	Unplugger	8-10	30-38	
		BN18 044-A	Universal	11-14	42-53	
15-22	1000-1500	BN18 044-B	Universal	8-10	30-38	
		BN18 042-C	Polisher	11-14	42-53	
		BN18 042-D	Polisher	8-10	30-38	
		BN18 043-C	Unplugger	11-14	42-53	
		BN18 043-D	Unplugger	8-10	30-38	
		BN18 044-C	Universal	11-14	42-53	

22K (1500 BAR) TOOL NUMBERS

PRESSURE		PART NUMBER	STYLE	FLOW RANGE		
Kpsi	bar			gpm	lpm	
BN24 HEAD SELECTION						
10-15	700-1000	BN24 042-A	Polisher	20-25	76-95	
		BN24 042-B	Polisher	15-19	57-72	
		BN24 042-C	Polisher	12-14	45-53	
		BN24 044-A	Universal	20-25	76-95	
		BN24 044-B	Universal	15-19	57-72	
		BN24 044-C	Universal	12-14	45-53	
15-22	1000-1500	BN24 042-D	Polisher	18-21	68-80	
		BN24 042-E	Polisher	15-17	57-64	
		BN24 042-F	Polisher	12-14	45-53	
		BN24 044-D	Universal	18-21	68-80	
		BN24 044-E	Universal	15-17	57-64	
		BN24 044-F	Universal	12-14	45-53	
BN33 HEAD SELECTION						
10-15	700-1000	BN33 044-A	Universal	40-49	150-190	
		BN33 044-B	Universal	33-39	130-150	
		BN33 044-C	Universal	26-32	98-120	
		BN33 044-D	Universal	20-25	76-95	
		BN33 044-E	Universal	15-19	57-72	
15-22	1000-1500	BN33 044-F	Universal	22-26	83-98	
		BN33 044-G	Universal	18-21	68-80	
		BN33 044-H	Universal	15-17	57-64	
		BN33 044-I	Universal	12-14	45-53	

40K (2800 BAR) TOOL NUMBERS

PRESSURE		PART NUMBER	STYLE	FLOW RANGE		
Kpsi	bar			gpm	lpm	
BN13 40K HEAD SELECTION						
30-40	2100-2800	BN13 442-C	Polisher	5.5-6	21-23	
		BN13 442-D	Polisher	4.5-5	17-19	
		BN13 443-C	Unplugger	5.5-6	21-23	
		BN13 443-D	Unplugger	4.5-5	17-19	
BN18 40K HEAD SELECTION						
30-40	2100-2800	BN18 442-A	Polisher	8-8.5	30-32	
		BN18 442-B	Polisher	7-7.5	27-28	
		BN18 442-C	Polisher	6-6.5	23-25	
		BN18 442-D	Polisher	5-5.5	19-21	
		BN18 443-A	Unplugger	8-8.5	30-32	
		BN18 443-B	Unplugger	7-7.5	27-28	
		BN18 443-C	Unplugger	6-6.5	23-25	
		BN18 443-D	Unplugger	5-5.5	19-21	
BN27 40K HEAD SELECTION						
30-40	2100-2800	BN27 442-A	Polisher	8-8.5	30-32	
		BN27 442-B	Polisher	7-7.5	27-28	
		BN27 442-C	Polisher	6-6.5	23-25	
		BN27 442-D	Polisher	5-5.5	19-21	
		BN27 443-A	Unplugger	8-8.5	30-32	
		BN27 443-B	Unplugger	7-7.5	27-28	
		BN27 443-C	Unplugger	6-6.5	23-25	
		BN27 443-D	Unplugger	5-5.5	19-21	

TERMS AND CONDITIONS AND WARRANTY INFORMATION

1. Acceptance of Terms and Conditions. Receipt of these Terms and Conditions of Sale ("Terms and Conditions") shall operate as the acceptance by StoneAge, Inc. ("Seller") of the order submitted by the purchaser ("Buyer"). Such acceptance is made expressly conditional on assent by Buyer to these Terms and Conditions. Such assent shall be deemed to have been given unless written notice of objection to any of these Terms and Conditions (including inconsistencies between Buyer's purchase order and this acceptance) is given by Buyer to Seller promptly on receipt hereof.

Seller desires to provide Buyer with prompt and efficient service. However, to individually negotiate the terms of each sales contract would substantially impair Seller's ability to provide such service. Accordingly, the product(s) furnished by Seller are sold only according to the terms and conditions stated herein and with the terms and conditions stated in any effective StoneAge Dealer Agreement or StoneAge Reseller Agreement, if applicable. Notwithstanding any terms and conditions on Buyer's order, Seller's performance of any contract is expressly made conditional on Buyer's agreement to these Terms and Conditions unless otherwise specifically agreed to in writing by Seller. In the absence of such agreement, commencement of performance, shipment and/or delivery shall be for Buyer's convenience only and shall not be deemed or construed to be an acceptance of Buyer's terms and conditions.

2. Payment/Prices. Unless other arrangements have been made in writing between Seller and Buyer, payment for the product(s) shall be made upon receipt of invoice. The prices shown on the face hereof are those currently in effect. Prices invoiced shall be per pricelist in effect at the time of shipment. Prices are subject to increase for inclusion of any and all taxes which are applicable and which arise from the sale, delivery or use of the product(s), and the collection of which Seller is or may be responsible to provide to any governmental authority, unless acceptable exemption certificates are provided by Buyer in accordance with applicable law. Buyer shall pay all charges for transportation and delivery and all excise, order, occupation, use or similar taxes, duties, levies, charges or surcharges applicable to the product(s) being purchased, whether now in effect or hereafter imposed by any governmental authority, foreign or domestic.

3. Warranty. SELLER MAKES NO WARRANTIES OR REPRESENTATIONS AS TO THE PERFORMANCE OF ANY PRODUCT EXCEPT AS SET FORTH IN THE STONEAGE LIMITED WARRANTY PROVIDED WITH THE PRODUCT.

4. Delivery. Seller is not obligated to make delivery by a specified date, but will always use its best efforts to make delivery within the time requested. The proposed shipment date is an estimate. Seller will notify Buyer promptly of any material delay and will specify the revised delivery date as soon as practicable. UNDER NO CIRCUMSTANCES SHALL SELLER HAVE ANY LIABILITY WHATSOEVER FOR LOSS OF USE OR FOR ANY DIRECT OR CONSEQUENTIAL DAMAGES RESULTING FROM DELAY REGARDLESS OF THE REASON(S).

All product(s) will be shipped F.O.B. point of origin, unless specifically agreed otherwise, and Buyer shall pay all shipping costs and insurance costs from that point. Seller, in its sole discretion, will determine and arrange the means and manner of transportation of the product(s). Buyer shall bear all risk of loss commencing with the shipment or distribution of the product(s) from Seller's warehouse. Order shortages or errors must be reported within fifteen (15) business days from receipt of shipment to secure adjustment. No product(s) may be returned without securing written approval from Seller.

5. Modification. These Terms and Conditions are intended by Seller and Buyer to constitute a final, complete and exclusive expression of agreement relating to the subject matter hereof and cannot be supplemented or amended without Seller's prior written approval.

6. Omission. Seller's waiver of any breach or Seller's failure to enforce any of these Terms and Conditions at any time, shall not in any way affect, limit or waive Seller's right thereafter to enforce and compel strict compliance with every term and condition hereof.

7. Severability. If any provision of these Terms and Conditions is held to be invalid or unenforceable, such invalidity or unenforceability shall not affect the validity or enforceability of the other portions hereof.

TERMS AND CONDITIONS AND WARRANTY INFORMATION

8. Disputes. Seller and Buyer shall attempt in good faith to promptly resolve any dispute arising under these Terms and Conditions by negotiations between representatives who have authority to settle the controversy. If unsuccessful, Seller and Buyer shall further attempt in good faith to settle the dispute by nonbinding third-party mediation, with fees and expenses of such mediation apportioned equally to each side. Any dispute not so resolved by negotiation or mediation may then be submitted to a court of competent jurisdiction in accordance with the terms hereof. These procedures are the exclusive procedures for the resolution of all such disputes between the Seller and Buyer.

9. Governing Law. All sales, agreements for sale, offers to sell, proposals, acknowledgments and contracts of sale, including, but not limited to, purchase orders accepted by Seller, shall be considered a contract under the laws of the State of Colorado and the rights and duties of all persons, and the construction and effect of all provisions hereof shall be governed by and construed according to the laws of such state.

STONEAGE TRADEMARK LIST

View the list of StoneAge's trademarks and service marks and learn how the trademarks should be used. Use of StoneAge trademarks may be prohibited, unless expressly authorized.

<http://www.StoneAgetools.com/trademark-list/>

STONEAGE PATENT DATA

View the list of StoneAge's current U.S. patent numbers and descriptions.

<http://www.sapatents.com>

STONEAGE TERMS AND WARRANTY

View StoneAge's Terms and Warranty Conditions online.

<http://www.stoneagetools.com/terms>

<http://www.stoneagetools.com/warranty>

10. Jurisdiction and Venue. Seller and Buyer agree that the state or federal courts located within the City and County of Denver, Colorado shall have sole and exclusive jurisdiction over any litigation concerning any dispute arising under these Terms and Conditions not otherwise resolved pursuant to Section 9 as well as any alleged defects of any Products or damages sustained as a result of such alleged defects. Seller and Buyer further agree that should any litigation be commenced in connection with such a dispute, it shall only be commenced in such courts. Seller and Buyer agree to the exclusive jurisdiction of such courts and neither will raise any objection to the jurisdiction and venue of such courts, including as a result of inconvenience.

11. Attorney's Fees. If any litigation is commenced between Seller and Buyer, or their personal representatives, concerning any provision hereof, the party prevailing in the litigation shall be entitled, in addition to such other relief that is granted, to a reasonable sum as and for their attorneys' fees and costs in such litigation or mediation.

WARRANTY:

Warranties set forth herein extend only to End-Users, meaning customers acquiring, or that have previously acquired, a product manufactured by StoneAge ("Product") for their own use and not for resale, either directly from StoneAge Inc. ("StoneAge") or from a StoneAge Authorized Dealer or Reseller ("Dealer"). No warranty of any kind or nature is made by StoneAge beyond those expressly stated herein.

1. LIMITED WARRANTY PERIOD. Subject to the limitations and conditions hereinafter set forth, StoneAge warrants its Product to be free from defects in workmanship and material for a period of one (1) year from the date of purchase by the End-User, provided that the end of the limited warranty period shall not be later than eighteen (18) months from the date of shipment of the Product to the Dealer or the End-User by StoneAge ("Limited Warranty Period"). All replacement parts which are furnished under this Limited Warranty and properly installed shall be warranted to the same extent as the original Product under this Limited Warranty if, and only if, the original parts were found to be defective within the original Limited Warranty Period covering the original Product. Replacement parts are warranted for the remainder of the original Limited Warranty Period. This Limited Warranty does not cover any component part of any Product not manufactured by StoneAge. Any such component part is subject exclusively to the component manufacturer's warranty terms and conditions.

2. LIMITED WARRANTY COVERAGE. StoneAge's sole obligation under this Limited Warranty shall be, at StoneAge's option and upon StoneAge's inspection, to repair, replace or issue a credit for any Product which is determined by StoneAge to be defective in material or workmanship. StoneAge reserves the right to examine the alleged defective Product to determine whether this Limited Warranty is applicable, and final determination of limited warranty coverage lies solely with StoneAge. No statement or recommendation made by a StoneAge representative, Dealer or agent to End-User shall constitute a warranty by StoneAge or a waiver or modification to any of the provisions hereof or create any liability for StoneAge.

3. WARRANTY SERVICE PROVIDERS. Service and repair of the Product is to be performed only by StoneAge authorized service representatives, including Dealers who are authorized repair centers, with StoneAge approved parts. Information about StoneAge authorized service representatives can be obtained through the StoneAge website at www.stoneagetools.com/service. Unauthorized service, repair or

modification of the Product or use of parts not approved by StoneAge will void this Limited Warranty. StoneAge reserves the right to change or improve the material and design of the Product at any time without notice to End-User, and StoneAge is not obligated to make the same improvements during warranty service to any Product previously manufactured.

4. WARRANTY EXCLUSIONS. This Limited Warranty does not cover, and StoneAge shall not be responsible for the following, or damage caused by the following: (1) any Product that has been altered or modified in any way not approved by StoneAge in advance in writing; (2) any Product that has been operated under more severe conditions or beyond the rated capacity specified for that Product; (3) depreciation or damage caused by normal wear and tear, failure to follow operation or installation instructions, misuse, negligence or lack of proper protection during storage; (4) exposure to fire, moisture, water intrusion, electrical stress, insects, explosions, extraordinary weather and/or environmental conditions including, but not limited to lightning, natural disasters, storms, windstorms, hail, earthquakes, acts of God or any other force majeure event; (5) damage to any Product caused by any attempt to repair, replace, or service the Product by persons other than StoneAge authorized service representatives; (6) costs of normal maintenance parts and services; (7) damage sustained during unloading, shipment or transit of the Product; or (8) failure to perform the recommended periodic maintenance procedures listed in the Operator's Manual accompanying the Product.

5. REQUIRED WARRANTY PROCEDURES. To be eligible for warranty service, the End-User must: (1) report the Product defect to the entity where the Product was purchased (i.e. StoneAge or the Dealer) within the Limited Warranty Period specified in this Limited Warranty; (2) submit the original invoice to establish ownership and date of purchase; and (3) make the Product available to a StoneAge authorized service representative for inspection to determine eligibility for coverage under this Limited Warranty. This Limited Warranty shall not extend to any person or entity who fails to provide proof of original purchase from StoneAge or a Dealer. No Product may be returned for credit or adjustment without prior written permission from StoneAge.

TERMS AND CONDITIONS AND WARRANTY INFORMATION

6. **DISCLAIMER OF IMPLIED WARRANTIES AND OTHER REMEDIES.** EXCEPT AS EXPRESSLY STATED HEREIN (AND TO THE FULLEST EXTENT ALLOWED UNDER APPLICABLE LAW), STONEAGE HEREBY DISCLAIMS ALL OTHER WARRANTIES, EXPRESS OR IMPLIED, INCLUDING WITHOUT LIMITATION ALL IMPLIED WARRANTIES OF MERCHANTABILITY OR FITNESS FOR A PARTICULAR PURPOSE, AND ANY AND ALL WARRANTIES, REPRESENTATIONS OR PROMISES AS TO THE QUALITY, PERFORMANCE OR FREEDOM FROM DEFECT OF THE PRODUCT COVERED BY THIS LIMITED WARRANTY. STONEAGE FURTHER DISCLAIMS ALL IMPLIED INDEMNITIES.

7. **LIMITATION OF LIABILITY.** End-User specifically acknowledges that the Product may be operated at high speeds and/or pressures, and that as such it may be inherently dangerous if not used correctly. End-User shall familiarize itself with all operation materials provided by StoneAge and shall at all times use and require its agents, employees and contractors to use all necessary and appropriate safety devices, guards and proper safe operating procedures. In no event shall StoneAge be responsible for any injuries to persons or property caused directly or indirectly by the operation of the Product if End-User or any agent, employee, or contractor of End-User: (1) fails to use all necessary and appropriate safety devices, guards and proper safe operating procedures; (2) fails to maintain in good working order such safety devices and guards; (3) alters or modifies the Product in any way not approved by StoneAge in advance in writing; (4) allows the Product to be operated under more severe conditions or beyond the rated capacity specified for the Product; or (5) otherwise negligently operates the Product. End-User shall indemnify and hold StoneAge harmless from any and all liability or obligation incurred by or against StoneAge, including costs and attorneys' fees, to or by any person so injured.

TO THE FULL EXTENT ALLOWED BY APPLICABLE LAW, STONEAGE SHALL NOT BE LIABLE FOR ANY INDIRECT, SPECIAL, INCIDENTAL, CONSEQUENTIAL, OR PUNITIVE DAMAGES (INCLUDING WITHOUT LIMITATION, LOSS OF PROFITS, LOSS OF GOODWILL, DIMINUTION OF VALUE, WORK STOPPAGE, INTERRUPTION OF BUSINESS, RENTAL OF SUBSTITUTE PRODUCT, OR OTHER COMMERCIAL LOSS EVEN TO THE EXTENT SUCH DAMAGES WOULD CONSTITUTE DIRECT DAMAGES), WITH RESPECT TO THE COVERED STONEAGE PRODUCT, OR OTHERWISE IN CONNECTION WITH THIS LIMITED WARRANTY, REGARDLESS OF WHETHER STONEAGE HAS BEEN

ADVISED OF THE POSSIBILITY OF SUCH DAMAGES.

IT IS UNDERSTOOD THAT STONEAGE'S LIABILITY, WHETHER IN CONTRACT, IN TORT, UNDER ANY WARRANTY, IN NEGLIGENCE, OR OTHERWISE SHALL NOT EXCEED THE AMOUNT OF THE PURCHASE PRICE PAID BY THE END-USER FOR THE PRODUCT. STONEAGE'S MAXIMUM LIABILITY SHALL NOT EXCEED, AND END-USER'S REMEDY IS LIMITED TO EITHER (1) REPAIR OR REPLACEMENT OF THE DEFECTIVE WORKMANSHIP OR MATERIAL OR, AT STONEAGE'S OPTION, (2) REFUND OF THE PURCHASE PRICE, OR (3) ISSUANCE OF A CREDIT FOR THE PURCHASE PRICE, AND SUCH REMEDIES SHALL BE END-USER'S ENTIRE AND EXCLUSIVE REMEDY.

YOU, THE END-USER, UNDERSTAND AND EXPRESSLY AGREE THAT THE FOREGOING LIMITATIONS ON LIABILITY ARE PART OF THE CONSIDERATION IN THE PRICE OF THE STONEAGE PRODUCT YOU PURCHASED.

Some jurisdictions do not allow the limitation or exclusion of liability for certain damages, so the above limitations and exclusions may not apply to you. This Limited Warranty gives you specific legal rights, and you may also have other rights which vary from jurisdiction to jurisdiction. If any provisions of this Limited Warranty is held to be invalid or unenforceable, such invalidity or unenforceability shall not affect the validity or enforceability of the other portions hereof.



1-866-795-1586 • www.STONEAGETOOLS.com

© 2021 StoneAge, Inc. All Rights Reserved